



# Installation Manual



## Fiber Optic Transmission Systems

VOS-4FOM-SCCT/R series

4-Channel Simplex Contact Closure Transmission

VOSCOM TECHNOLOGIES CO., LIMITED

[WWW.VOSCOM.COM](http://WWW.VOSCOM.COM)

1. Read these instructions. Keep these instructions. Heed all warnings. Follow all instructions.
5. Do not use this apparatus near water. Clean only with dry cloth.
7. Do not block any ventilation openings. Install in accordance with the manufacturers instructions.
8. Do not install near any heat sources such as radiators, heat registers, stoves, or other apparatus (including amplifiers) that produce heat.
9. Do not defeat the safety purpose of the polarized or grounding-type plug. A polarized plug has two blades with one wider than the other. A grounding type plug has two blades and a third grounding prong. The wide blade or the third prong are provided for your safety. If the provided plug does not fit into your outlet consult an electrician for replacement of the obsolete outlet.
10. Protect the power cord from being walked on or pinched particularly at plugs, convenience receptacles, and the points where they exit from the apparatus.
13. Refer all servicing to qualified service personnel. Servicing is required when the apparatus has been damaged in any way, such as power-supply cord or plug is damaged, liquid has been spilled or objects have fallen into the apparatus, the apparatus has been exposed to rain or moisture, does not operate normally, or has been dropped.
14. Apparatus shall not be exposed to dripping or splashing and that no objects filled with liquids, such as vases shall be placed on the apparatus.
15. **WARNING:** To reduce the risk of fire or electric shock, do not expose this apparatus to rain or moisture.
16. Installation should be done only by qualified personnel and conform to all local codes.
20. **CAUTION:** These servicing instructions are for use by qualified service personnel only. To reduce the risk of electric shock do not perform any servicing other than that contained in the operating instructions unless you are qualified to do so.

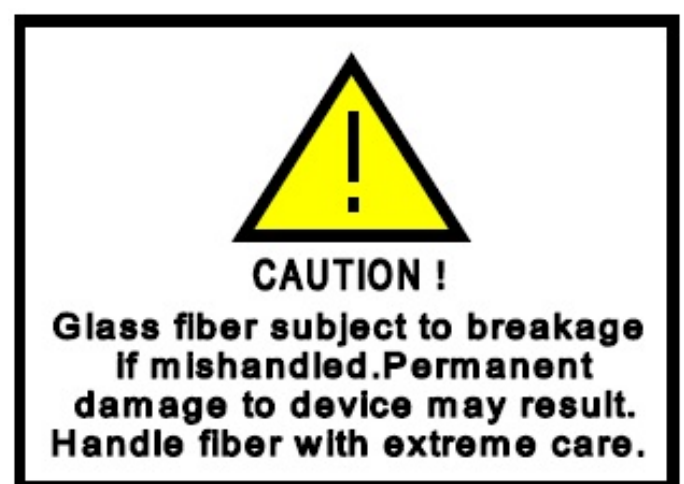

The VOS-4FOM-SCCT/R can transmission 4-Channel simplex contact closure over singlemode or multimode optical cable.

Stand-alone or rack-mount. The cards can be inserted into our 14 slots, 19inch 4U or 6U rack-mountable card cage (VOS-CH04 or VOS-CH06).

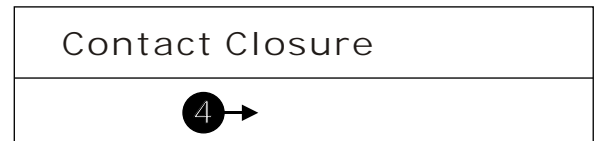

**Features:**

- Dry Contact Closure or TTL data over one fiber
- Multi-mode Fiber Support for Distances up to 2.0 km
- Single-Mode Fiber Support for Distances up to 100 km
- No EMI or RFI and no ground loops
- Stand alone or rack-mount

**Models and Optical Power Budget:**

Model Number		Fiber Mode	Wavelengths	Optical Power Budget	Maximum Transmission Distance
Transmitter	Receiver				
VOS-4FOM-SCCMT	VOS-4FOM-SCCMR	Multi-Mode	1310nm	16dB	2km
VOS-4FOM-SCCST	VOS-4FOM-SCCSR	Single-Mode	1310nm	12dB	20km
VOS-4FOM-SCCST-4	VOS-4FOM-SCCSR-4	Single-Mode	1310nm	18dB	40km
VOS-4FOM-SCCST-6	VOS-4FOM-SCCSR-6	Single-Mode	1310nm	25dB	60km

**Note:**

- The Optical Power Budget data fit Mulit-mode(62.5/125 μ m), Single-Mode(9/125 μ m).
- When using 50/125 μ m multimode fiber, subtract 3 dB from the optical power budget.
- Optical transmission distance is limited to optical loss of the fiber and any additional loss introduced by connectors, splices and patch panels.
- Maximum transmission distance is also limited by fiber bandwidth.
- Power adapter is manufactured by third party and is supplied with fitted screw-terminal output cables. Power adapter included (for standalone) US, European, UK or Australian power plug.
- Please feel free to consult factory for any special requirement and customization

**System Diagram:**

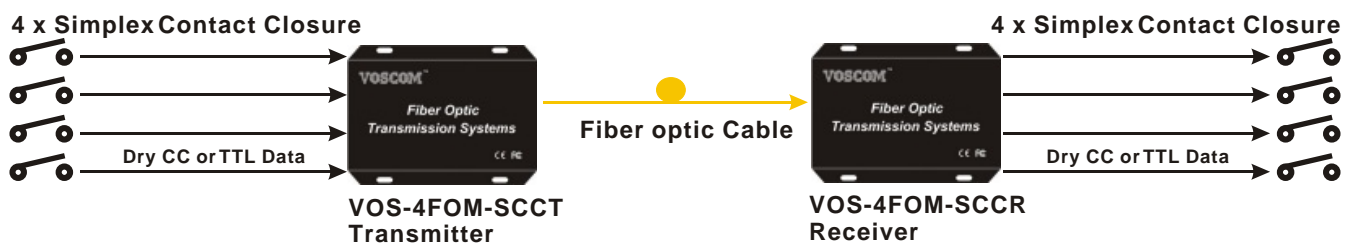

Note: More detail specification please find in the datasheet or our website: [www.voscom.com](http://www.voscom.com)

## Installation Instructions:

NOTE1: Digital fiber optic transmitter and receiver should be used in pairs, one is Transmitter (LED is red), the other is Receiver (LED is green).

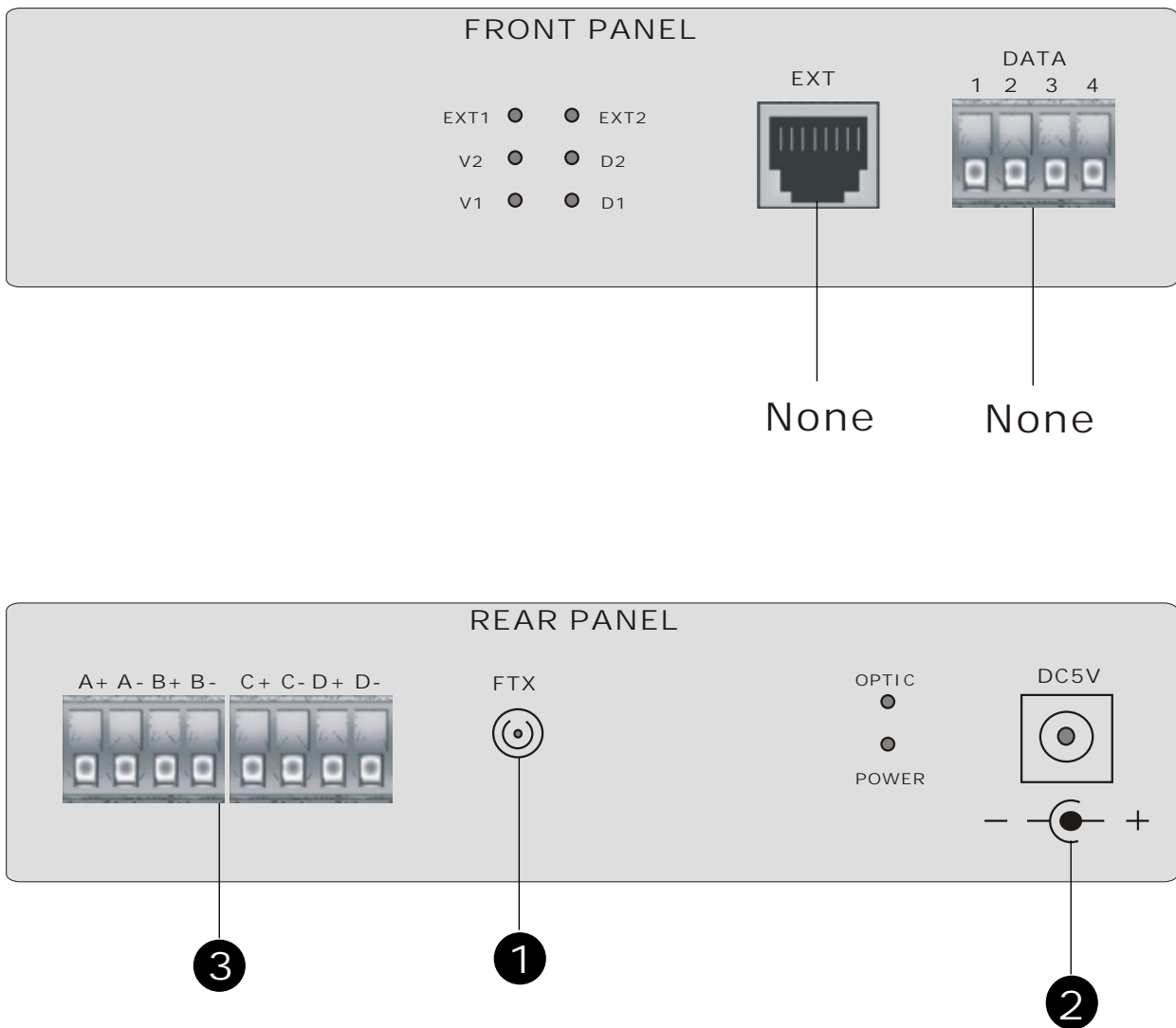

- ❶ Fiber Optic Connector, FC/PC or ST/PC
- ❷ Stand-alone Power supply Connector, DC5V 2A Input.
- ❸ Terminal Block Connector, contact closure input (Transmitter) / output (Receiver).

## Installation Instructions:

NOTE1: Digital fiber optic transmitter and receiver should be used in pairs, one is Transmitter (LED is red), the other is Receiver (LED is green).

### Transmitter: 4-Channel Simplex Contact Closure Connection (Input)

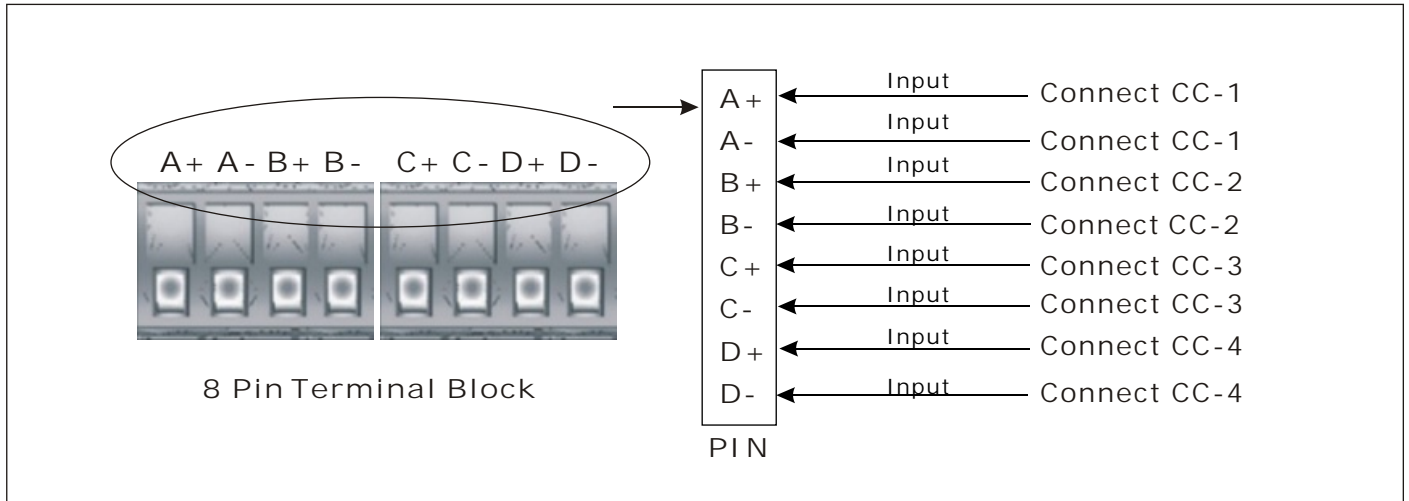

### Receiver: 4-Channel Simplex Contact Closure Connection (Output)

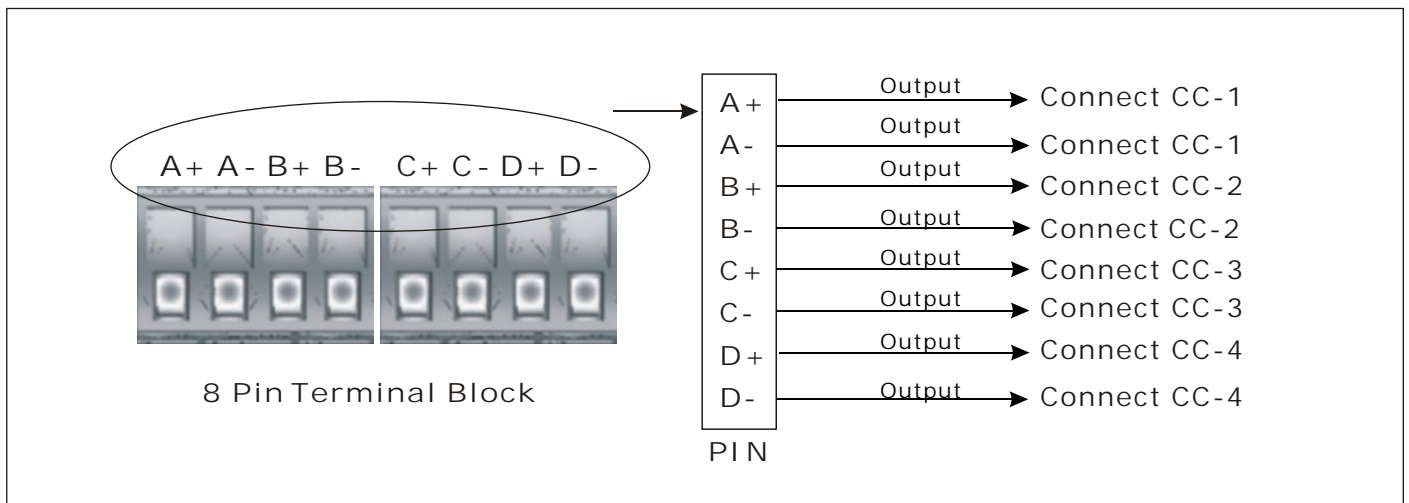

The VOS-4FOM-SCCT transmitter and VOS-4FOM-SCCR receiver can be mounted into a rack or can be used as a stand-alone module. As a stand-alone module, the unit can be placed on a desktop or can be mounted to a wall.

NOTE: Before mounting the VOS-4FOM-SCCT transmitter and VOS-4FOM-SCCR receiver, please ensure that there is adequate space at both ends for viewing the front-panel LEDs and for making the various rear-panel cable connections.

Stand-alone Mounting Size: 142mm x 107mm x 25mm

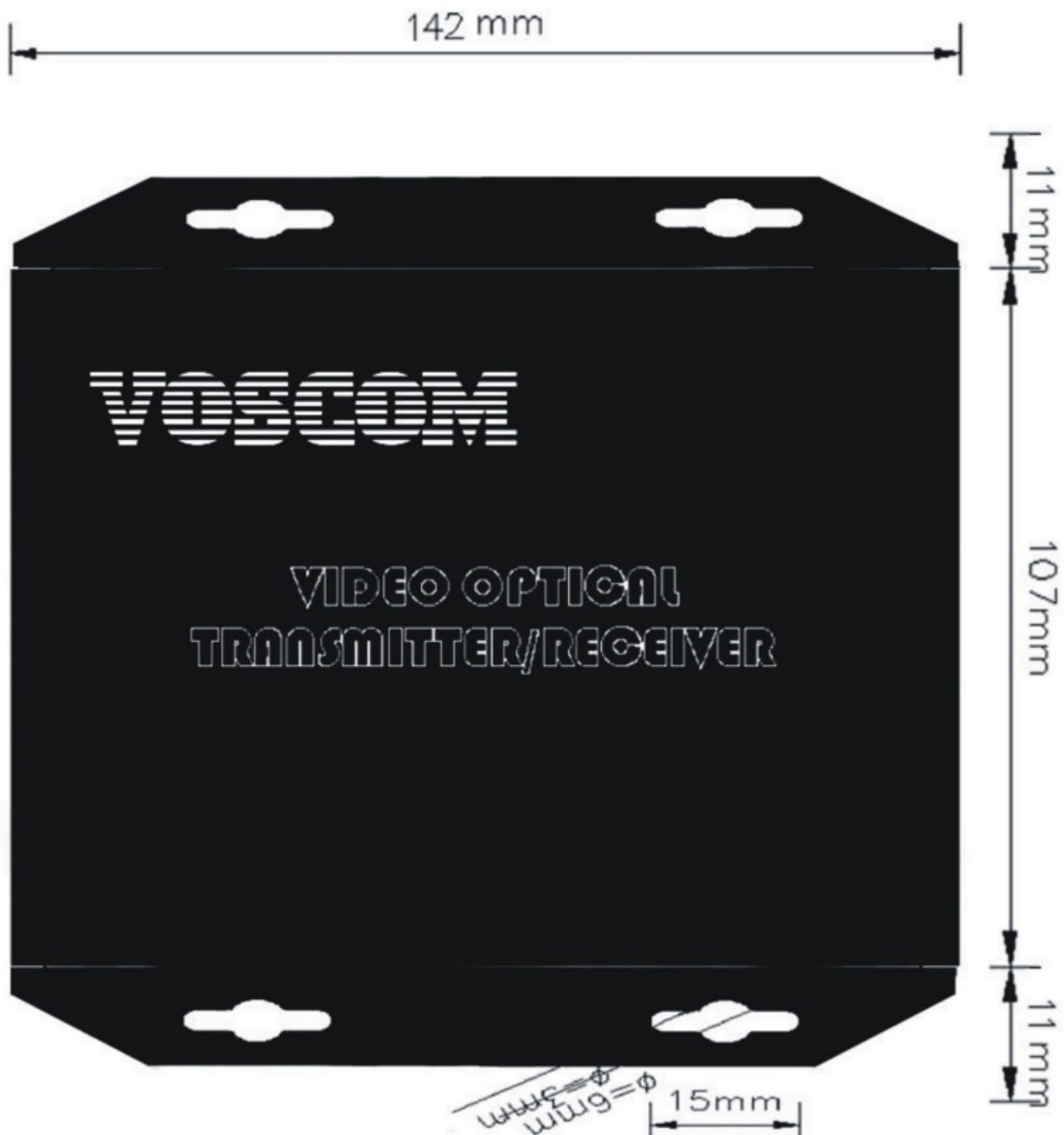

The VOS-4FOM-SCCT transmitter/VOS-4FOM-SCCR receiver can be installed into our rack mount chassis, VOS-CH04 or VOS-CH06, which can be mounted into an industry-standard 19-inch equipment rack.

## Installation Instructions

- 1: Install the video card into a standard 19inch rack, using user-supplied rack-mounting hardware. Be careful to not damage exposed objects on the back of the card cage unit.
- 2: If a secondary earth ground connection is needed, a grounded wire with a ground lug can be attached to the rack using the protruding screw provided on the right side of the chassis.
- 3: If desired, blank panels may be installed to cover unused slots. A single blank panel covers a single slot opening.
- 4: Each fiber optic plug-in module is equipped with a POWER LED indicator that illuminates when power is applied to the rack unit.
- 5: Fiber optic plug-in modules(video cards) can be installed into any of the available 14 slots of the card cage. Most modules require only a single slot width, but others, such as the 8-Ch video Series, require two slot widths.

### VOS-CH04:

19 inch 4U, 14 video card slots, suit for 1-ch, 2-ch, 4-ch, 8-ch(two slots) video cards.  
Support one slide-in power supply AC100V~AC240V

### VOS-CH06:

19 inch 6U, 16 video card slots, suit for 1-ch, 2-ch, 4-ch, 8-ch(two slots) video cards.  
Support two slide-in power supply AC100V~AC240V, one for redundancy.

## Typical Configurations:

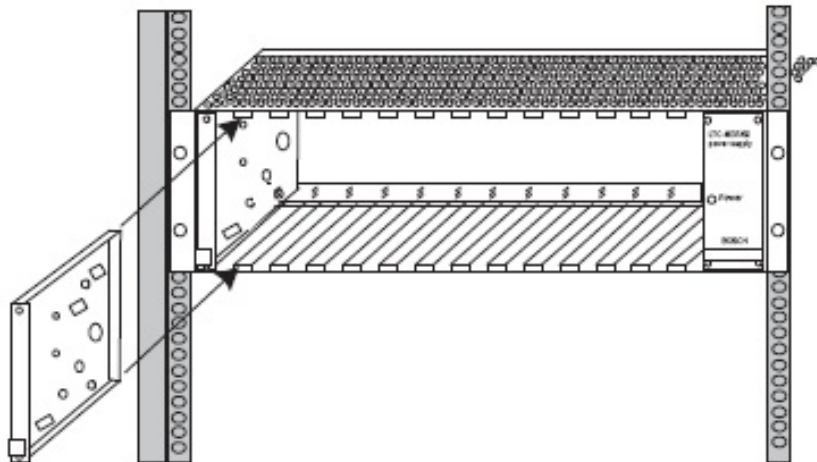

LED indicators on the front-panel of the transmitter/receiver allow you to monitor signal status, laser status, data activity, contact closure activation, and operating power. Table A~D provide information about the front-panel indicators and associated troubleshooting guidelines.

Table A: Power Links

Indicator Status	Meaning	Possible Cause	Corrective Action
Power LED			
Light	Power is being applied to the module.	---	No action required.
Not Light	Power is not being applied to the module.	Power connection is faulty.	Check power connection. If module is rack mounted, reseal module or power supply as necessary.
		Power supply has failed.	Replace power supply.
		Loss of power occurs due to tripped circuit breaker(s), blown fuse(s), or faulty electrical service.	Check circuit breaker(s), fuse(s), or electrical service as necessary.

Table B: Video Links

Indicator Status	Meaning	Possible Cause	Corrective Action
Video LED(VI DEO 1,VI DEO 2....)			
Light	Incoming video signal is present on the channel.	---	No action required.
Not Light on Transmitter	Incoming video signal is not present on the channel.	Video source is not powered on.	Check power connection to the video source.
		Video source is not connected to the transmitter.	Check BNC connections.
		Coaxial cable is defective.	Replace cable.
Not Light on Receiver	Incoming video signal is not present on the channel.	Optical signal is not being received from the transmitter. Optic Fault LED is also not light.	Refer to the Optic Fault LED section in this table.
		Video source is not powered on.	Check power connection to the video source.
		Video source is not connected to the transmitter.	Check BNC connections.
		Coaxial cable connected to the transmitter is defective.	Replace cable.



Table C: Data Links

Indicator Status	Meaning	Possible Cause	Corrective Action
Data(RS485/RS232/RS422) LED			
Flashing	Data is being transmitted onto the fiber by the data port or is being received from the fiber by the data port.	---	No action required.
Not Light	Data is not being transmitted onto the fiber by the data port or is not being received from the fiber by the data port.	Data is not present on the channel.	No action required.
		Data connection is faulty.	Check data connections.
		Data communication cable is defective.	Replace cable.

Table B: Optic Links

Indicator Status	Meaning	Possible Cause	Corrective Action
Optic LED			
Light	The optical signal is being received and laser is operating properly.	---	No action required.
Not Light	The optical signal is not being received.	Remote fiber module is not powered on.	Check power connections. Replace power supply if necessary.
		Fiber optic cable is not connected.	Check fiber optic connections.
		Fiber optic cable connectors are dirty or are damaged.	Clean, polish, or replace fiber optic cable connectors as necessary.
		Fiber optic cable is defective.	Replace cable.
		A problem exists with the optical power budget.	Verify that losses in fiber optic cable do not exceed the optical power budget specification of the fiber optic link. If the losses do exceed the optical power budget, contact Product Support.

## Warranty Introduction

All VOSCOM manufactured products are warranted to be free from defects in manufacturing and materials for the warranty term of *3 years*. VOSCOM will repair or replace any equipment or parts proved to be defective during the term of the warranty.

VOSCOM shall not be obligated to replace or repair equipment that has been damaged by fire, war, acts of God, or similar causes, or equipment that has been serviced by unauthorized personnel, altered, improperly installed or abused.

This Return and Warranty Policy Statement applies to VOSCOM equipment purchased directly from VOSCOM Technology Co.,Ltd. If you did not acquire the VOSCOM equipment directly, return the equipment to the place of purchase.

## Returning VOSCOM products

Before you can return any product to VOSCOM, you must obtain a Return Material Authorization (RMA). This applies to all product returns, including warranty repair/replacements, nonwarranty repairs, advance replacements, and credit returns.

To obtain an RMA, (Download from [www.voscom.com](http://www.voscom.com)), and please complete the RMA as much detail as possible, then send the RMA to our customer service support:

FAX: +86-571-87389390

E-mail: [RMA@voscom.com](mailto:RMA@voscom.com)

Customer Service will provide you with an RMA number and an RMA acknowledgment form that confirms your request.

Once you have the RMA, repackage the product appropriately and attach the RMA acknowledgment form on the outside of the package. Then send the product to the return location given by the customer service center.

All products must be returned freight prepaid within 30 days of obtaining an RMA. We reserve the right to cancel the RMA after 30 days. If you fail to return the product within the 30 days, please contact Customer Service to get a new RMA.

We will not accept unauthorized returns or freight collection returns; we will return these to you at your expense.

If a returned product contains parts that are no longer available or repairable, we will contact you to discuss resolution and return of the material.

## Warranty repair/replacements

Subject to the terms of the limited warranty in effect at the time of purchase, VOSCOM will repair or replace a product that fails to meet the terms provided, within the product's warranty period. The actual warranty period starts from either:

- a): The date of shipment from VOSCOM's facility (point of origin)
- b): The manufacturer's date code (if the shipment date is unknown).

For all warranty repairs, VOSCOM will cover parts and labor. We will return equipment via the same incoming shipment method at no additional charge.

## Non-warranty repairs

For all non-warranty repairs, VOSCOM will provide you with a repair estimate that includes charges for parts, labor (in half-hour increments), and all shipping. Repair charges may be based on a flat rate or parts and labor, and will vary based on actual equipment and condition. You may pay for non-warranty repair charges by purchase order.

## Advance replacement

Advance replacement products are new or like-new refurbished products and carry a full original equipment warranty. VOSCOM will send advance replacement product to replace defective equipment that has failed upon initial install for up to 60 days from the original date of shipment. We will ship advance replacements in the next business day.

Our repair department will evaluate the returned product to determine whether it is a warranty or non-warranty replacement and bill you accordingly. We will invoice advance replacements at shipment and credit you upon receipt of the defective product. If we determine, however, that the returned product is in good working order or that performance issues were due to improper installation, misuse, abuse, or other user-related causes, we will issue no credit and you will remain responsible for paying the invoice.

Note: Advance replacement is not available for custom products.

## Credit returns

VOSCOM will refund or credit new, standard production items that are unused and in the original unopened shipping cartons for a period of 60 days from the original date of shipment. All returned merchandise is subject to a 20% restocking fee. Products that have failed upon initial install within 60 days from the date of shipment (or date of manufacture if shipment date is unknown) may be returned for credit without a restocking fee. (Products purchased as part of a kit must be returned through *Advance replacement*.)

As with advance replacements, if we determine that the returned product is in good working order or that performance issues were due to improper installation, misuse, abuse, or other user-related causes, we will issue no credit and you will remain responsible for paying the invoice.

Note: Credit is not available for custom products.

## Manufacture Packing List:

Fiber Optic Transmitter	1
Fiber Optic Receiver	1
Power Adapter	2
User Manual	1

Network Cable with RJ-45 connector (If the product with RJ-45 port)

## Note:

- 1): VOSCOM reserves the right to change specifications without notice.
- 2): You can download the latest PDF document here: [www.voscom.com](http://www.voscom.com)
- 3): Online Technical Support please E-mail: [support@voscom.com](mailto:support@voscom.com)
- 4): More detail product information please E-mail: [sales@voscom.com](mailto:sales@voscom.com), or contact with our sales staff.
- 5): Return defective products please download RMA here: [www.voscom.com](http://www.voscom.com)
- 6): Get an acknowledgment RMA number please complete the RMA as much detail as possible and then E-mail: [RMA@voscom.com](mailto:RMA@voscom.com) or FAX: +86-571-87389390

# WARNING

TO REDUCE THE RISK OF FIRE OR SHOCK HAZARD, DO NOT EXPOSE THIS PRODUCT TO RAIN OR MOISTURE.

DO NOT LOOK INTO OPTICAL PORTS WITH POWER ON.

## Headquarters Information:

VOSCOM TECHNOLOGIES CO., LIMITED  
Hangzhou, Zhejiang, P.R.CHINA 310004  
Tel: +86-571-87389389  
Fax: +86-571-87389390  
Web: [www.voscom.com](http://www.voscom.com)  
E-Mail: [sales@voscom.com](mailto:sales@voscom.com)  
[support@voscom.com](mailto:support@voscom.com)  
[RMA@voscom.com](mailto:RMA@voscom.com)

## Distributor Information: